



Automation for a Changing World

Delta Integrated Elevator Drive IED Series



www.delta.com.tw/ia

 **DELTA**
Smarter. Greener. Together.

Delta Integrated Elevator Drives IED Series

Delta Electronics, a leading brand in industrial automation, introduces integrated elevator devices with newly developed technology. Delta's IED series meets international safety standards (UL/CE) and integrates host controller and drive to vastly improve the operation performance and reliability of the elevator. The single MCU design of the IED series is space saving and suitable for various applications in different markets for passenger and freight elevators. It is designed with provisions for full technical and maintenance support and offers one-stop shopping for all you need in an elevator drive. The planning, assembly, technology and additional services are all included with the Delta IED series. Delta as your most reliable partner presents this specialized solution for ultimate performance.

IED

I = Integration
Independent
Indispensable

E = Easy to use
Economical
Environment friendly

D = Design
Drive
Deliver



Integration that meets the highest standards of the elevator industry



I



I = Integrated

- Integrates host controller and drive functions
- A single MCU provides for all operation needs

I = Independent

- Flexible applications with various types of auto-tuning for synchronous and asynchronous motors, also applicable to various encoders
- Unlimited applications, from low speed to high speed elevators, freight elevators and passenger elevators

I = Indispensable

- Provides for all your needs from key components to total system solutions
- Global sales locations provide you with rapid service

E



E = Easy to Use

- Simple parameter settings
- Intelligent on-site auto-tuning

E = Economical

- On-site tuning with load
- Accurate direct-stop and automatically generates speed curve of car traveling

E = Environment Friendly

- With selective power generation unit to create a more eco-friendly solution
- Conforms to UL and CE certifications

D



D = Design

- Innovative design for hardware protection, ensuring safe elevator operation
- Modular design for easy installation and maintenance

D = Drive

- Professional motor and drive control technology
- Smooth elevator motion, perfect stop and start

D = Deliver

- Provides true integration, flexible and indispensable elevator solutions
- Delta's IED delivers for you

IED Features

Auto-tuning with load

- Ability to perform auto-tuning with loads when elevator structure is completed. (Saves you the hassle of re-assembling the elevator structure)
- Supports varied types of encoders when elevator is with loads
- Precisely measures the motor parameters with loads present
- Precisely measures the PG offset angle with loads present
- Simple and easy tuning for construction site applications. No need to add loads for balancing
- Safe, reliable, and labor-saving

Smooth start and stop without load compensation

- Easy adjustment with simple testing process
- Applicable to any elevator structure, provides precise control, consistent efficiency and not affected at all by external conditions
- Auto-adjustment of starting torque to provide a smooth and comfortable ride

Fast and smooth torque control after mechanical brake release

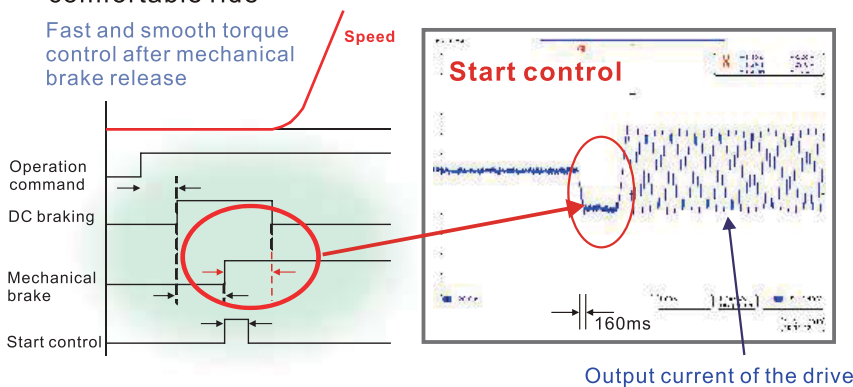

Compact design of control cabinet to strengthen the structure



146mm

- Thin body design, with a minimum thickness of 146mm

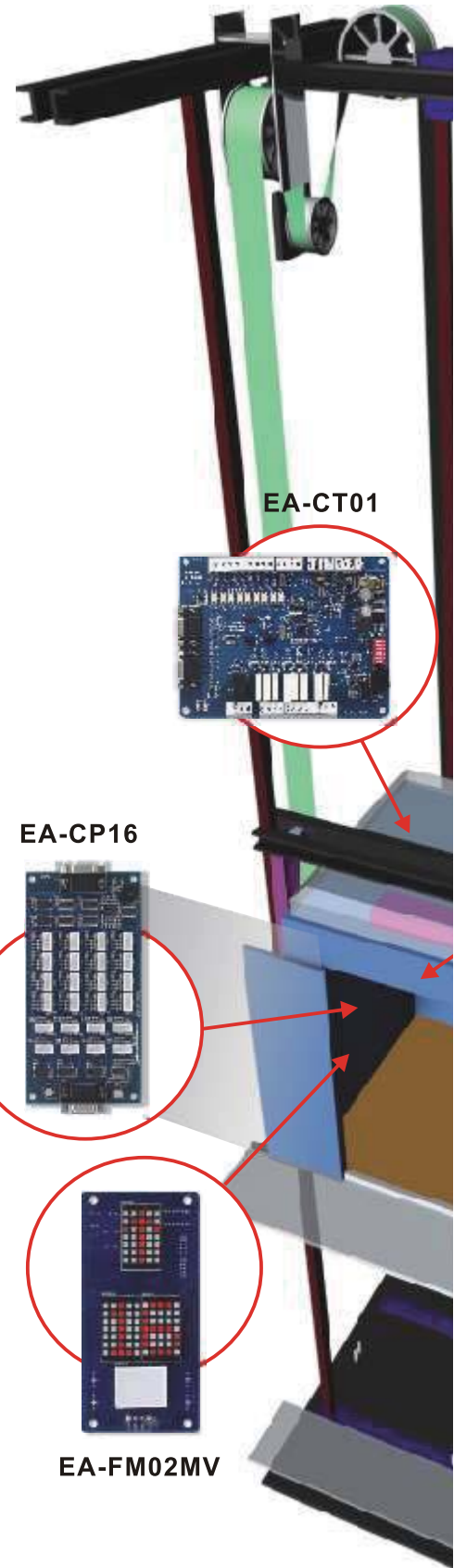



IED

Reliable ride with comfort and safety ensured

- Auto-detection on output phase loss to ensure proper operation of motor
- Automatic confirmation on torque output before releasing the mechanical brake

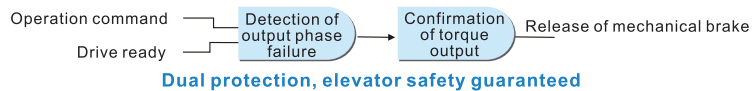

Dual protection, elevator safety guaranteed

- Supports single-phase 230 VAC UPS and executes a light-load direction search automatically when power failure occurs.

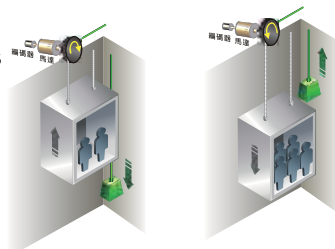

In case of power failure the light-load direction search function is triggered to bring the elevator car to the nearest floor instantly.

EA-FM02MH



EA-FM02MV



Built-in digital keypad with easy-to-use features

- Optional LCD (KPC-CC01), a pull-out type digital keypad supporting multi-languages is available upon purchase.



USB port convenient for program upload/download and facilitating the tuning process

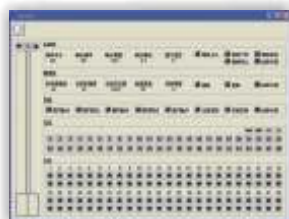



Applications Fields and Speed:

- Passenger elevators, medical elevators, elevators for disabled, elevators for housing, elevators for commercial buildings
- Low speed, mid speed and high speed elevators
- Elevator speed: 4m/sec

A fully integrated drive technology in one MCU

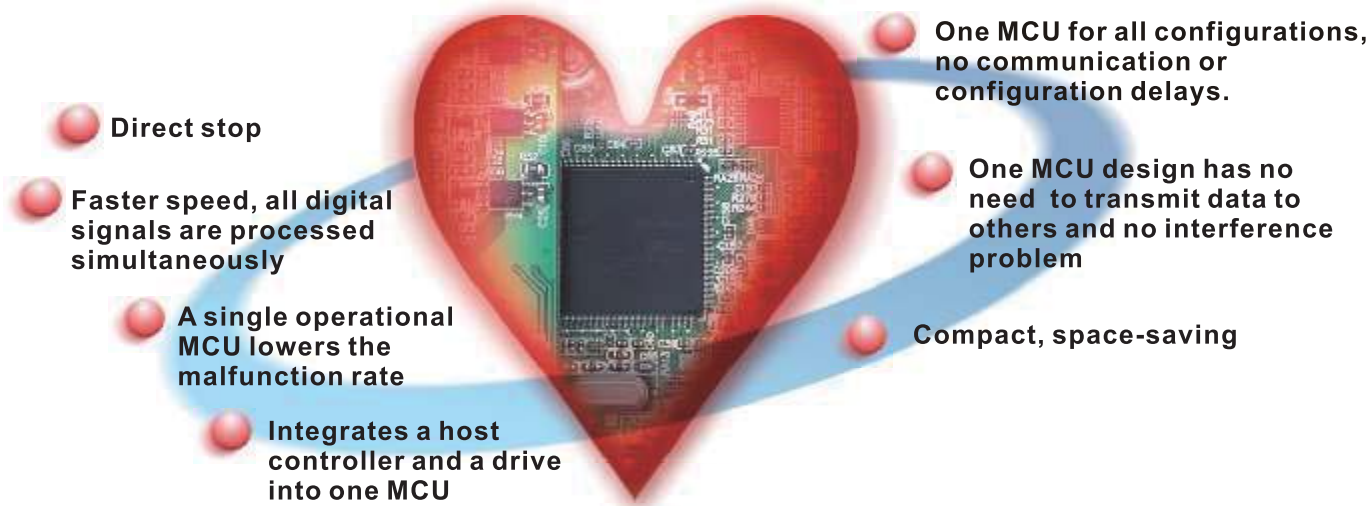

One MCU	Two MCUs
Fast calculation for Direct Stop 🏆	Slow calculation for Direct Stop
Faster speed, all digital signals are processed simultaneously 🏆	Slower speeds, digital signals are processed separately.
A single operational MCU lowers the malfunction rate 🏆	Two MCUs processing simultaneously increase the malfunction rate.
One MCU does all configurations, no communication or configuration delays 🏆	Two MCUs compute separately and interact through mutual communication causing delays in computing time.
One MCU does all configurations, no communication or interference problems 🏆	Two MCUs compute separately and transfer data to each other, causing errors due to interference.
Compact, space-saving 🏆	Two MCUs are space consuming.
Integrates host controller and drive into one MCU 🏆	One MCU for host controller and one MCU for drive.





IED Features

■ **Operator inspection mode:**

When the elevator is undergoing maintenance or inspection, this mode allows an operator to conduct a low speed run via the maintenance switches located on the top of the car, inside the car or on the control board.

■ **Direct stop:**

With floor distances and parameters settings provided to the system, this feature calculates and configures the optimal speed curve automatically for the elevator to operate from start to stop.

■ **Real-time speed curve configuration:**

The elevator's speed curve is configured in real-time to operate between floors with different travel distances.

■ **Default door opening:**

The elevator door prepares for opening as it detects the floor arrival sensor when traveling. This function shortens the waiting time for door to open.

■ **Automatic re-leveling when door opens:**

Floor leveling may fluctuate when weight changes or when false operation occurs. This mode automatically re-levels the elevator at low speed as the door opens.

■ **Rescue operation to the nearest floor:**

When power failure occurs suddenly, the elevator automatically travels to the nearest floor for landing to ensure passenger safety.

■ **Auto-tuning with load:**

This feature enables auto-tuning for a dynamic or static motor that is equipped with a load. The elevator rope does not need to be removed.

■ **Fire operation:**

When fire alarm is ON, the elevator automatically returns to the rescue floor and will not respond to any calls from the hall to ensure passenger safety.

■ **Encoder offset auto-tuning with load:**

This feature supports various encoder types and encoder offset tuning of permanent magnetic motors. Also enables auto-tuning for a dynamic or static motor that is equipped with load. The elevator rope does not need to be removed.

■ **Attendant operation:**

When the attendant switch is pressed inside the elevator car, the attendant operation mode is ON and an operator inside the elevator can (1) answer calls from the elevator hall and decide whether to accept or decline the call, (2) control the elevator door's open and close, (3) control elevator travel up and down.

■ **Energy saving lights and fans control:**

The lighting and fans are automatically turned off for energy-saving purposes when there are no instructions from inside the elevator or calls from the hall during the set time.

■ **Automatic detection of floor heights:**

Floor heights are automatically measured and saved into the MCU as the elevator travels from the top floor to the bottom floor. This feature automatically calculates the leveling position for landing and the optimal operation speed for traveling between each floor.



- **Automatic adjustment of car position:**

The car position is constantly monitored and analyzed by the system. When it fails to match with the system analysis due to malfunctions or human errors, the elevator will automatically return to the nearest position correction zone for adjustment. Once the car position is identified, the elevator is restored to normal operation status.

- **False car call cancellation:**

This function allows a user to cancel the wrong floor selection pressed on the control board.

- **Cancellation of reverse direction instructions:**

When the elevator responds to calls in the same direction or when the traveling direction is reversed, the reverse direction calls are erased and will not be registered.

- **Load by-pass:**

When the elevator detects a full load greater than 80% of the car's rated capacity, it will only respond to the floor selected inside the elevator. All calls from the hall are registered but will delay response until the car's weight is reduced to lower than 80% of the rated capacity.

- **Time-based service:**

The elevator can be set to respond to only certain floor instructions or to travel between certain floors during a set time.

- **Rush hour operation:**

During rush hours, the elevators will only respond to the car instructions after departing from the base floor and will return to the base floor automatically (ignoring calls from the hall) after the last call from the car is finished.

- **Anti-nuisance function:**

If the system detects and determines any nuisance during operation, the elevator lands at the nearest floor registered on the control board and automatically clears the rest of the calls to minimize wasted energy.

- **Overload protection:**

When the elevator car weight exceeds 110% of the car's rated capacity, the buzzer sounds and stops the door from closing.

Control Terminals

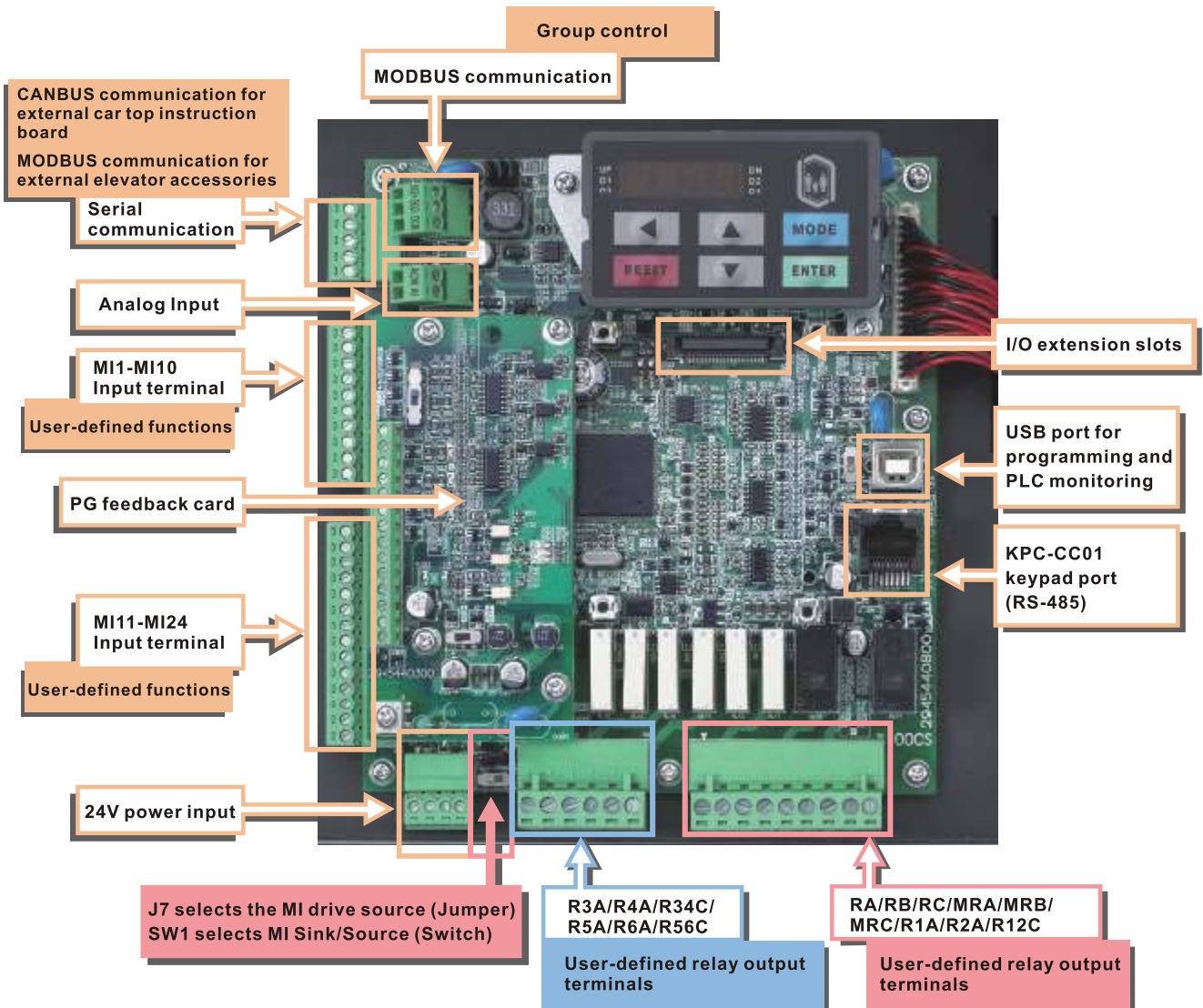

Name	Quantity	Terminal
Multi-function digital input	24 sets, up to a maximum 40 sets via I/O extension slots	<ol style="list-style-type: none"> 1. User-defined functions 2. Photo coupler 3. Input impedance: approximately 3.75kΩ 4. Input voltage: 0~24VDC
Multi-function relay output	2 sets (N.O./N.C.) 6 sets (N.O.)	<ol style="list-style-type: none"> 1. User-defined functions 2. Resistive load 5A(N.O.)/3A(N.C.) 250VAC 5A(N.O.)/3A(N.C.) 30VDC 3. Inductive load (COS 0.4) 2.0A(N.O.)/1.2A(N.C.) 250VAC 2.0A(N.O.)/1.2A(N.C.) 30VDC
MODBUS communication	3 sets	<ol style="list-style-type: none"> 1. Communicate with KPC-CC01 (optional) 2. Communicate with floor panels 3. Communicate with host controller for monitoring purpose 4. Communication for group control
CANBUS communication	1 set	<ol style="list-style-type: none"> 1. Communicate with the car top instruction board
USB port	1 set	<ol style="list-style-type: none"> 1. Computer monitoring, programming
Analog input	1 set	<ol style="list-style-type: none"> 1. Input voltage: +10 V~-10V 2. Input impedance 20k 3. Resolution 12bit

Wiring

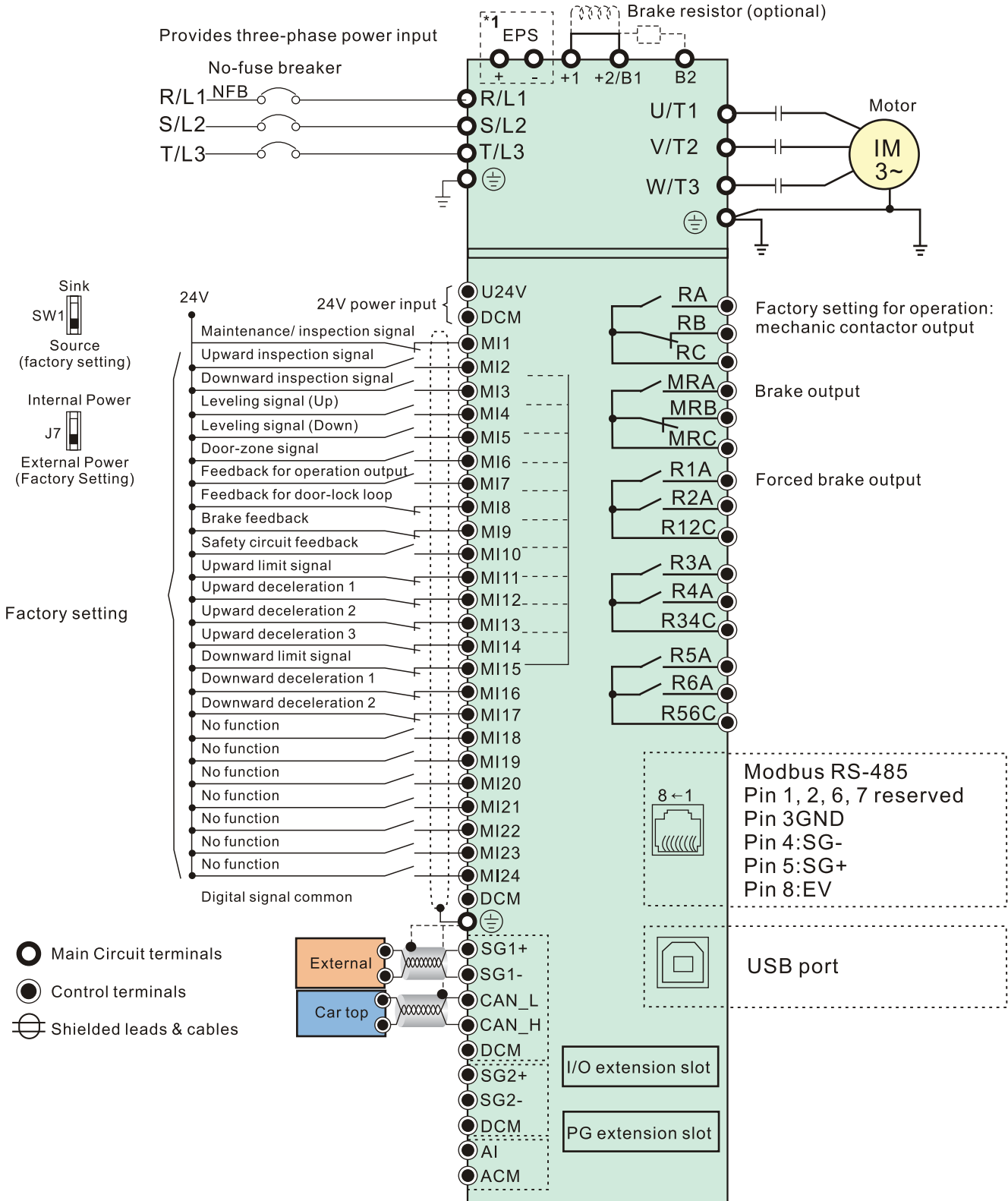

* 1. Terminals for supplying emergency power to control board or providing backup power supply. (Applicable to frame C and D models.)



Product Specifications

■ 230V Series

230V	Frame	B			C			D			E	
	Model IED___A23A	022*	037*	040	055	075	110	150	185	220	300	370
Output	Applicable Motor Output (kW)	2.2	3.7	4.0	5.5	7.5	11	15	18.5	22	30	37
	Applicable Motor Output (HP)	3	5	5	7.7	10	15	20	25	30	40	50
	Rated output capacity (kVA)	4.8	6.8	7.9	9.6	12	17.9	23.1	30.7	34.7	52.6	64.1
Output	Rated output for elevators (A)	13.7	19.6	22.8	27.4	34.3	51.4	66.3	88.0	99.4	151.0	184.0
	Maximum output voltage (V)	Three-phase corresponding input voltage										
	Range of output frequency (Hz)	0.00~400Hz										
	Carrier Frequency (kHz)	2~15kHz									2~9kHz	
Enter	Input Current (A)	26	37.4	25	30	38	56	723	95	107	163	200
	Input voltage range	Single-phase 200~240V 50/60Hz	Single-phase 200~240V 50/60Hz	Three-phase power supply 200~240V 50/60 Hz								
	Power voltage alteration allowed	10% (180~260V)										
	Power frequency alteration allowed	5% (47~63Hz)										
	Cooling method	Forced cold wind										

■ 460V Series

460V	Frame	*1B			C			D			*1E		
	Model IED___A43A	040	055	075	110	150	185	220	300	370	450	550	750
Output	Applicable Motor Output (kW)	4.0	5.5	7.5	11	15	18.5	22	30	37	45	55	75
	Applicable Motor Output (HP)	5	7.5	10	15	20	25	30	40	50	60	75	100
	Rated output capacity (kVA)	9.2	10.4	13.5	18.3	24	30.3	36	46.2	63.7	80	96.4	116.3
Output	Rated output for elevators (A)	13.1	14.9	19.4	26.3	34.3	43.4	51.4	66.3	92	114	138	1167
	Maximum output voltage (V)	Three-phase power of 380~480V 50/60Hz											
	Range of output frequency (Hz)	0.00~400Hz											
	Carrier Frequency (kHz)	2~15kHz						2~9kHz		2~6kHz			
Enter	Input Current (A)	17	18	22	28	37	47	56	72	99	123	150	180
	Input voltage range	Three-phase corresponding input voltage											
	Power voltage alteration allowed	10% (342~528V)											
	Power frequency alteration allowed	5% (47~63Hz)											
Cooling method	Forced cold wind												

* All 230V models are 3-phase except the following two models:
 1-phase 230V: IED022A21A (2.2kW)
 1-phase 230V: IED037A21A (3.7kW)



General Specifications

Control characteristics	Control method	1: V/F, 2: VF+PG, 3: SVC, 4: FOC+PG, 5: TQC+PG, 6: FOC+PM
	Starting torque	The starting torque can reach up to 150% or more at the frequency of 0.5 Hz. The control mode for FOC + PGC and FOC + PM is 0 Hz.
	Speed control range	1:100 (with external PG up to 1:1000)
	Speed control precision	+/-0.5% (up to +/-0.02% with external PG card)
	Speed response bandwidth	5Hz (vector control up to 40 Hz)
	Maximum output frequency (Hz)	0.00 to 400Hz
	Frequency output accuracy	Digital command 0.005%, analog command 0.5%
	Frequency setting resolution	Digital command 0.01 Hz, Analog command: 1/4096 (12 bit) of maximum output frequency
	Torque limit	Max. 200% of torque current
	Torque accuracy	±5%
Protection features	Acceleration/deceleration time	0.00~600.00 Sec
	Analog input signal	+/-10V
	Motor protection	Electronic thermal relay protection
	Over-current protection	200% of current clamp for rated current, 250% of over-current protection for rated current
	Ground current protection	Ground current protectin level is 50% of rated current of the AC motor drive
	Overload capacity	150% of rated output current for 60 seconds, 200% for 3 seconds
Environment	Over-voltage protection	Over-voltage level: Vdc > 410/820V
	Over-voltage protection for input power	Metal Oxide Varistor (MOV)
	Over-temperature protection	Built-in temperature sensor
	Protection level	NEMA 1/IP20
	Operation Temperature	-10°C~40°C, Derating up to 50°C
	Storage temperature	-20° C~60° C
	Humidity	Below 90% RH (no condensation)
	Vibration	1.0G below 20Hz, 0.6 G when 20~60Hz
Cooling System	Fan cooling (When IED is ON the fan turns ON; when IED is OFF the fan turns OFF)	
Installation height	Below the altitude of 1,000 m (non-corrosive gases and liquids, dust-free)	
International Certification		 

Dimensions of the IED Series

■ Frame:B

Models

- IED022A21A
- IED037A21A
- IED040A23A、IED040A43A

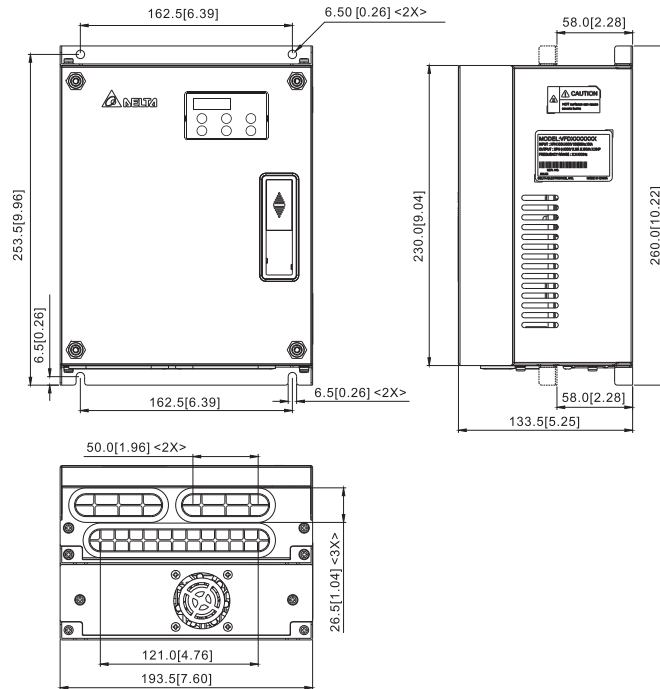

Unit:mm[inch]

■ Frame:C

Models

- IED055A23B、IED055A43B
- IED075A23B、IED075A43B
- IED110A23B、IED110A43B
- IED150A43B*
- IED185A43B*

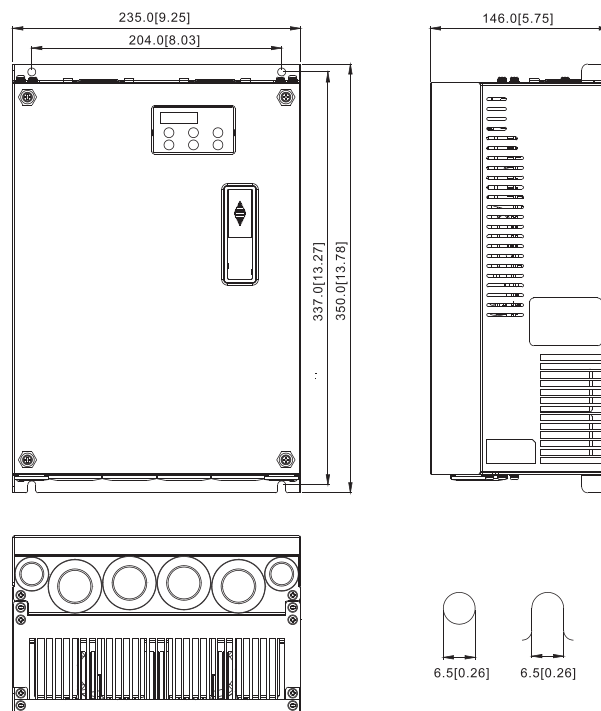

*2012 Q3上市

Unit:mm[inch]

■ **Frame:D**

Models

- IED150A23B、IED150A43A
- IED185A23B、IED185A43A
- IED220A23B、IED220A43B
- IED300A43A

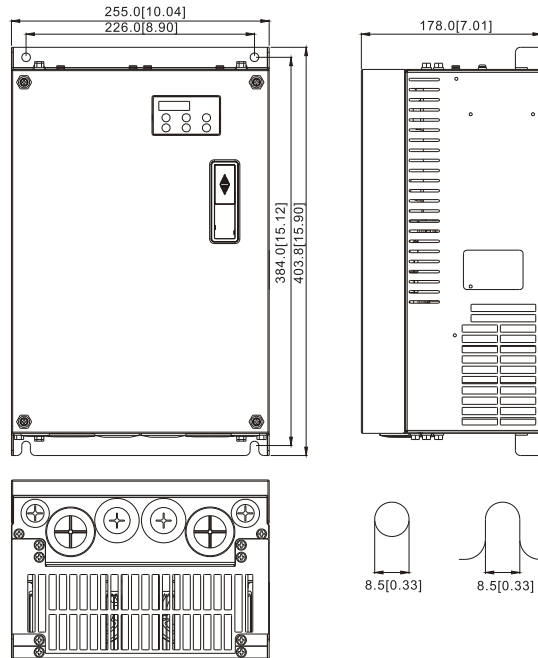

Unit:mm[inch]

■ **Frame:E**

models

- IED300A23A
- IED370A23A、IED370A43A
- IED450A43A
- IED550A43A
- IED750A43A

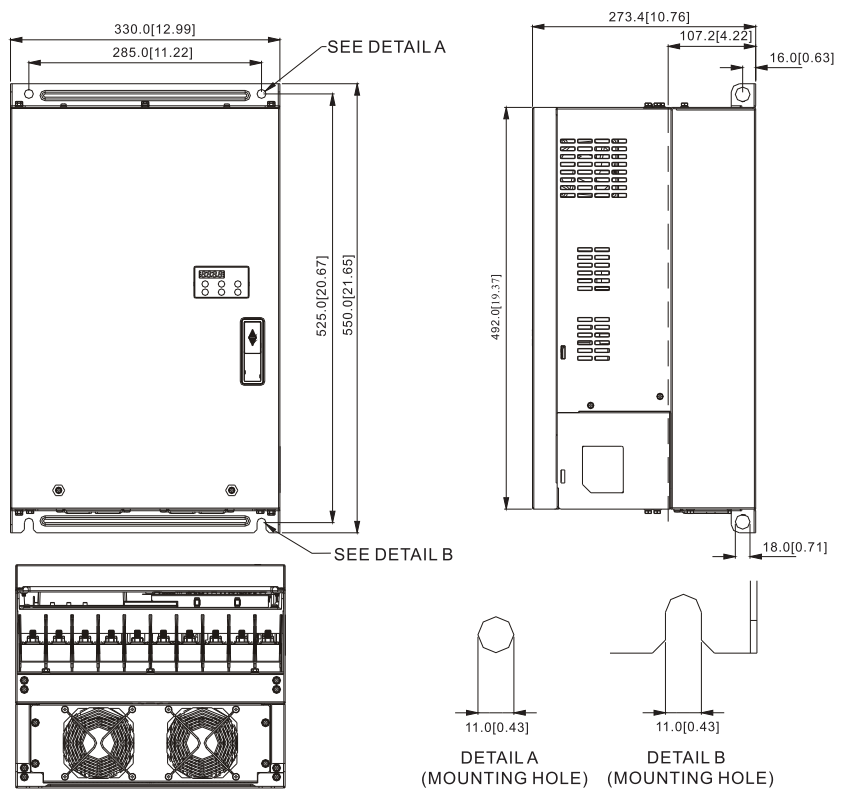

Unit:mm[inch]

Dimensions of Accessories

EA-CT01 Car-top Signal Junction Board

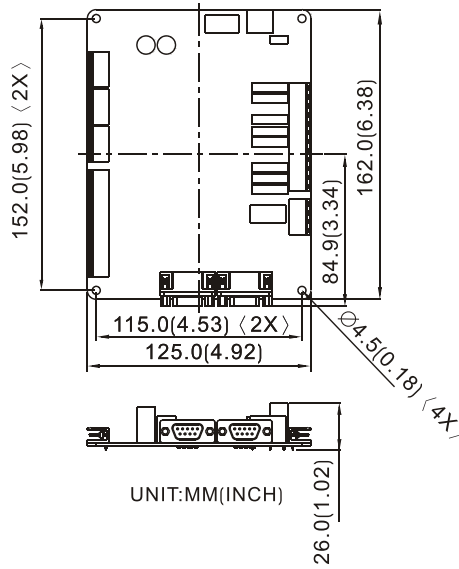

EA-CP16 Elevator Car Command Board

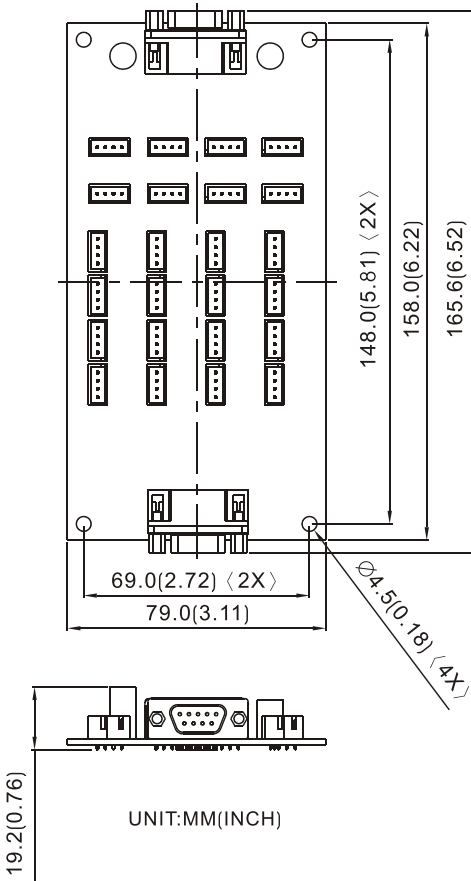

EA-CTP01 Integrated Elevator Car Command Board

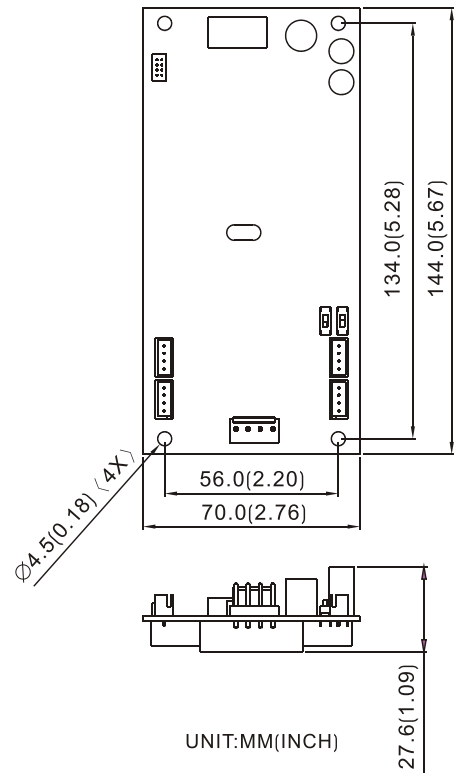

Dimensions of Accessories

EA-FM02MH Vertical/Horizontal Matrix Display Board

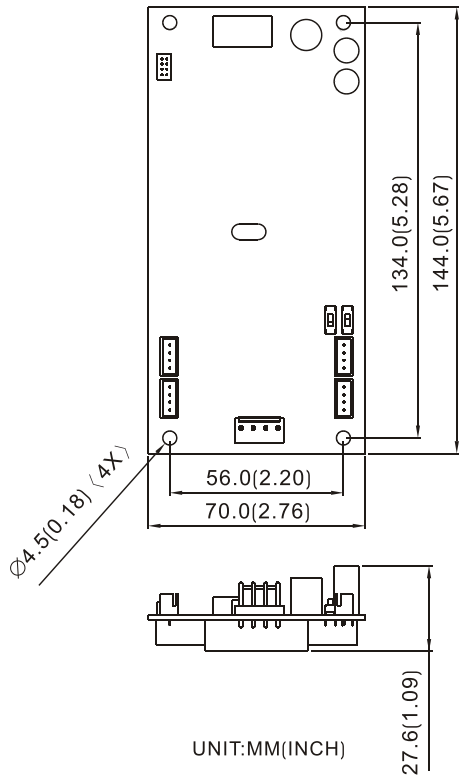

EA-FM02MV Vertical Display Board

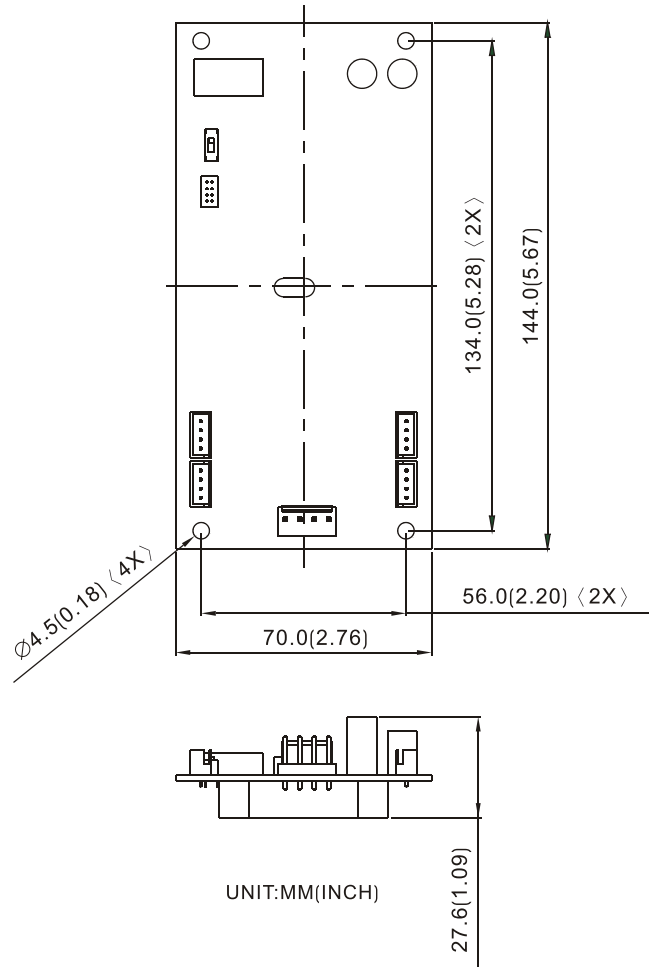

IED Accessories

Car-top Signal Junction Board (EA-CT01)



Terminals	Descriptions
I1	Front door open limit
I2	Front door close limit
I3	Front door light curtain signal input
I4	Back door open limit
I5	Back door close limit
I6	Back door light curtain signal
I7	Overload input
I8	Full load input
I9	Reserve
SAI/SBI/GND/VS	Analog input terminals for the connection of weighing signal input
CAN+ / CAN-	CAN communication
MOD+ / MOD-	Modbus communication
J4 , J5	Lift car command board communication
Ob2~Ob1-COMd	Front door open/close output
Oc1-COMc	Full load signal output
Oc3~Oc2-COMc	Back door open/close output
Oc1-COMb	Front door opening
Oc2-COMb	Fan output
Od3-COMb	Light output
NO-COMa/NC-COMa	Reserved

Elevator Car Command Board (EA-CP16)



Terminals	Descriptions
CN1	Connection to the car-top board, integrated car-top board, car display board
CN2	Extension slot for connection to another EA-CP16 (More than 16 floors applications)
JP1~JP16	Elevator car's floor button plug-in
JP17~JP24	Door open/close outputs; door open delay output; non-stop output; attendant operation output; independent operation output; fireman output, etc.
JP17	Front door open control
JP18	Front door close control
JP19	Front door open delay control/display
JP20	Load by pass (non-stop) control/display
JP21	Attendant control /display
JP22	Reverse direction of non-stop/attendant display
JP23	Independent operation control /display
JP24	Fireman control/display

Vertical/Horizontal Matrix Display Board (EA-FM02MH)



Terminals	Descriptions
J1	Modbus communication and power cord terminals, 4-pin interface: Pin 2 and Pin 3 are Modbus communication cable wires; Pin 1 and Pin 4 are power cord wires.
J2, J3	Up/Down call button interface: Pin 2 and Pin 3 are wires for number of input switches; Pin 1 and Pin 4 are used for button indicator output signal control
J4	For up-to-position/down-to-position indicator output signal control
J5	Fire/Lock button interface: Pin 1 and Pin 4 are used for Fire button input; Pin 2 and Pin 3 are used for Lock button input



Vertical Display Board (EA-FM02MV)



Terminals	Descriptions
J1	Modbus communication and power cord terminals, 4-pin interface: Pin 2 and Pin 3 are Modbus communication cable wires; Pin 1 and Pin 4 are power cord wires.
J2, J3	Up/Down call button interface: Pin 2 and Pin 3 are wires for number of input switches; Pin 1 and Pin 4 are used for button indicator output signal control
J4	Fire button interface: Pin 2 and Pin 3 are wires for number of input switches; Pin 1 and Pin 4 are used for button indicator output signal control
J5	Lock button interface: Pin 2 and Pin 3 are wires for number of input switches; Pin 1 and Pin 4 are used for button indicator output signal control

Integrated Elevator Car Command Board (EA-CTP01)



Terminals	Descriptions
I1	Front door open limit
I2	Front door close limit
I3	Front door light curtain input
I4	Back door open limit
I5	Back door close limit
I6	Back door light curtain signal
I7	Overload input
I8	Full load input
I9	Reserve
SAI/SBI/GND/VS	Analog input terminals for the connection of weighing signal input
CAN+ / CAN-	CAN communication
MOD+ / MOD-	Modbus communication
CN1	Connection to the primary car-top command board
CN2	Connection to the secondary car-top command board
JP1~JP16	Elevator car's floor button plug-in
JP17	Front door open control
JP18	Front door close control
JP19	Front door open delay control/display
JP20	Load by pass (non-stop) control/display
JP21	Attendant control /display
JP22	Reverse direction of non-stop/attendant display
JP23	Independent operation control /display
JP24	Fireman control/display
Ob1 ~ Ob3 Oc1 ~ Oc3 NO-AM/ NC-AM	Multifunction relay outputs Door open/close signals; Up-/down-to-position signals; Elevator car fan/light control;
Od2~Od1-COMd	Front door open/close output
Oc1-COMc	Full load signal output
Oc3~Oc2-COMc	Back door open/close output
Ob1-COMb	Front door opening
Ob2-COMb	Fan output
Ob3-COMb	Light output
NO-COMa / NC-COMa	Reserved



IED Accessories

Input card (EMED-D411A110V)



Terminals	Descriptions
HCM	Digital multi-function input terminals, AC power common
HI1~HI4	Input voltage: 100VAC~130VAC Input frequency: 57~63Hz

PG feedback card for open-collector, Line Driver and UVW encoder signal (EMED-PGAB)



Terminals	Descriptions
VP	Output power of encoder Output voltage: +5V/+12V (determined by SW1) Maximum output current: 200mA
0V	Power source common for encoder
A, /A, B, /B, Z, /Z	Incremental encoder signal input Line driver input complies to the RS422 standard Single-phase input of +12 V open collector signal (determined by SW2) Maximum input frequency: 100kHz
U, /U, V, /V, W, /W	Hall sensor signal input Maximum input frequency: 50kHz
SW1 SW2	Output voltage +5V/+12V selection Input encoder signal selection for open-collector/Line Driver

PG feedback card for Heidenhain ERN1387, EnDat2.1 and HIPERFACE (EMED-PGHSD)



Terminals	Descriptions
Vin	Port for voltage input (for adjusting the value of voltage amplitude from push-pull pulse output) Maximum input voltage: 24VDC
GND	Common ground for Vin and output signal
A/O, B/O	Signal for push-pull pulse output Maximum output current: 20mA Maximum output frequency: 50kHz
AO, /AO, BO, /BO	Signal for differential pulse output Maximum output current: 30mA Maximum output frequency: 100kHz
D-SUB Connector (J3)	Encoder signal input Supports Heidenhain ERN1387 encoder. Heidenhain EnDat2.1 SICK HIPERFACE
SW1 SW2	Output IN.P/EX.P selection Output voltage +5V/+12V selection



IED Accessories

Model and Accessories Selection

Category	IED Models	
	230VAC 1-phase/3-phase	460VAC 3-phase
A	IED022A21A	
	IED037A21A	
	IED040A23A	IED040A43A
	IED055A23B	IED055A43B
	IED075A23B	IED075A43B
	IED110A23B	IED110A43B
	IED150A23B	IED150A43B
	IED185A23B	IED185A43B
	IED220A23B	IED220A43B
	IED300A23A	IED300A43A
	ED370A23A	IED370A43A
		IED450A43A
		IED550A43A
		IED750A43A
Category	Accessories	
B-1.1	EA-CT01	Car-top signal junction board
B-1.2	EA-CP16	Elevator car command board
B-2	EA-CTP01	Integrated elevator car command board
C-1	EA-FM02MH	Vertical/horizontal matrix display board
C-2	EA-FM02MV	Vertical display board
G-1	EA-CB3C	CANopen communication cable
G-2	EA-CB05	CANopen communication cable
D-1	EMED-PGAB	PG feedback card
D-2	EMED-PGHSD	PG feedback card
E	EMED-D411A	110VAC input card
F	KPC-CC01	LCD keypad
<p>Example:</p> <p>How to select a suitable IED model and elevator accessories for the passenger elevator in a 7-floors building?</p> <p>=(A)+(B-1.1)+(B-1.2)+(C-1*)+7x(C-1*)+(G-2)+(D-1**)</p> <p>=(A)+(B-2)+(C-1*)+7x(C-1*)+(G-1)+(D-1**)</p> <p>*EA-FM02MH and EA-FM02MV are available for different elevator needs.</p> <p>*EMED-PGAB and EMED-PGHSD are available for different elevator needs.</p>		



IED Accessories

KPC-CC01



- Highly illuminated LCD display
- MODBUS RS-485 communication
- Supporting language:
Traditional Chinese,
Simplified Chinese, English

EA-CB3C

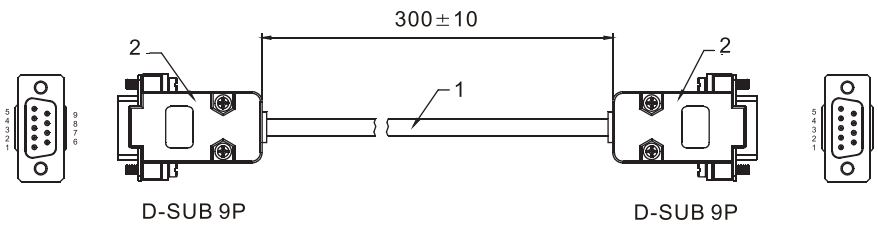

EA-CB05

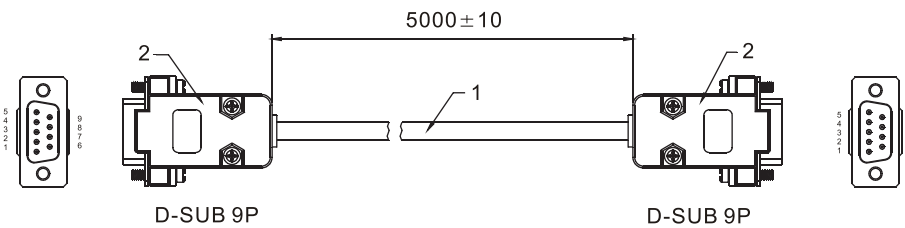

EA-CB3C	EA-CB05
Length : 300 ± 10mm	Length : 5000 ± 50mm
Connector : D-SUB 9PIN	Connector : D-SUB 9PIN
Cable: 9 cores, black, screened/shielded, bears 300V voltage	Cable: 9 cores, black, screened/shielded, bears 300V voltage



IED Car-top Signal Junction Board and Floor Display Boards Connection

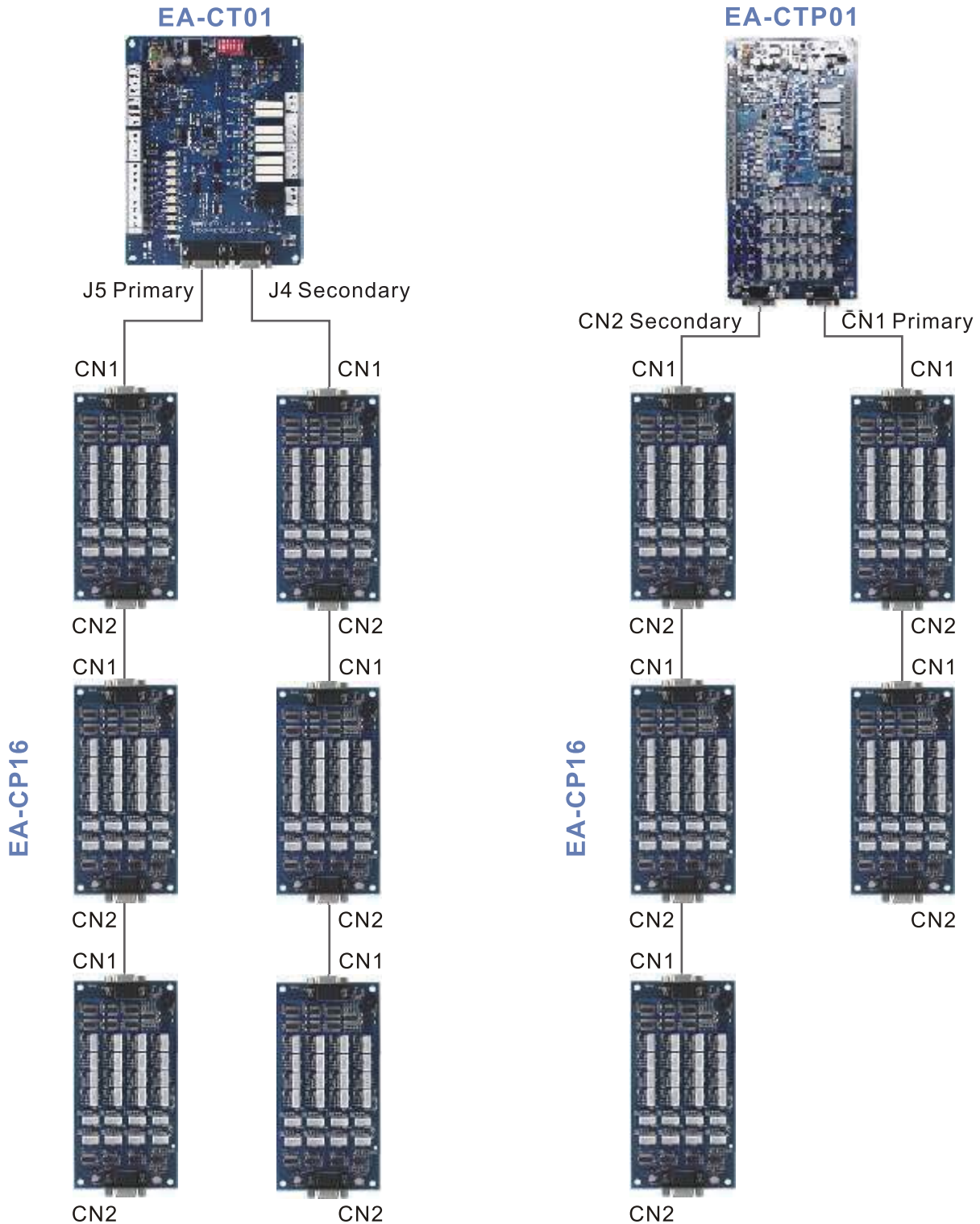

* JP5: max. connection to 3 sets of EA-CP16
 JP4: max. connection to 3 sets of EA-CP16
 * J5: For primary door control inside the elevator
 * J4: For secondary door control inside elevator

* The integrated elevator car command board (EA-CTP01) includes the functions of elevator car command board (EA-CP16)
 * CN1: max. connection to 2 sets of EA-CP16
 CN2: max. connection to 3 sets of EA-CP16
 * CN1: For primary door control inside the elevator
 CN2: For secondary door control inside elevator

Applications: IED Series and Accessories

Serial Connection (TB6)

Connects to car-top board via CANBUS and communicates to the hall via MODBUS

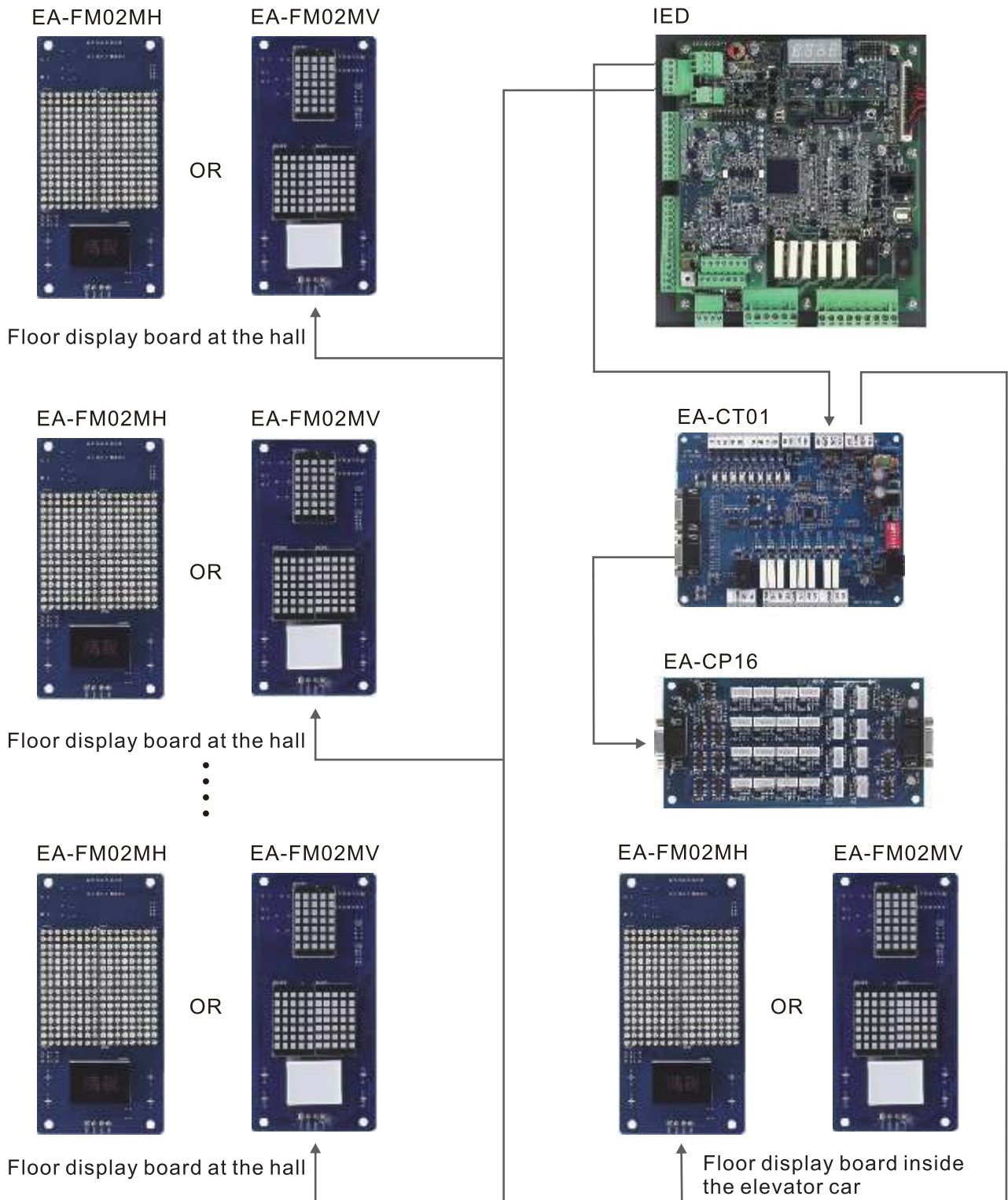

Serial Connection (TB6)

Connects to car-top board via CANBUS and communicates to the hall via MODBUS

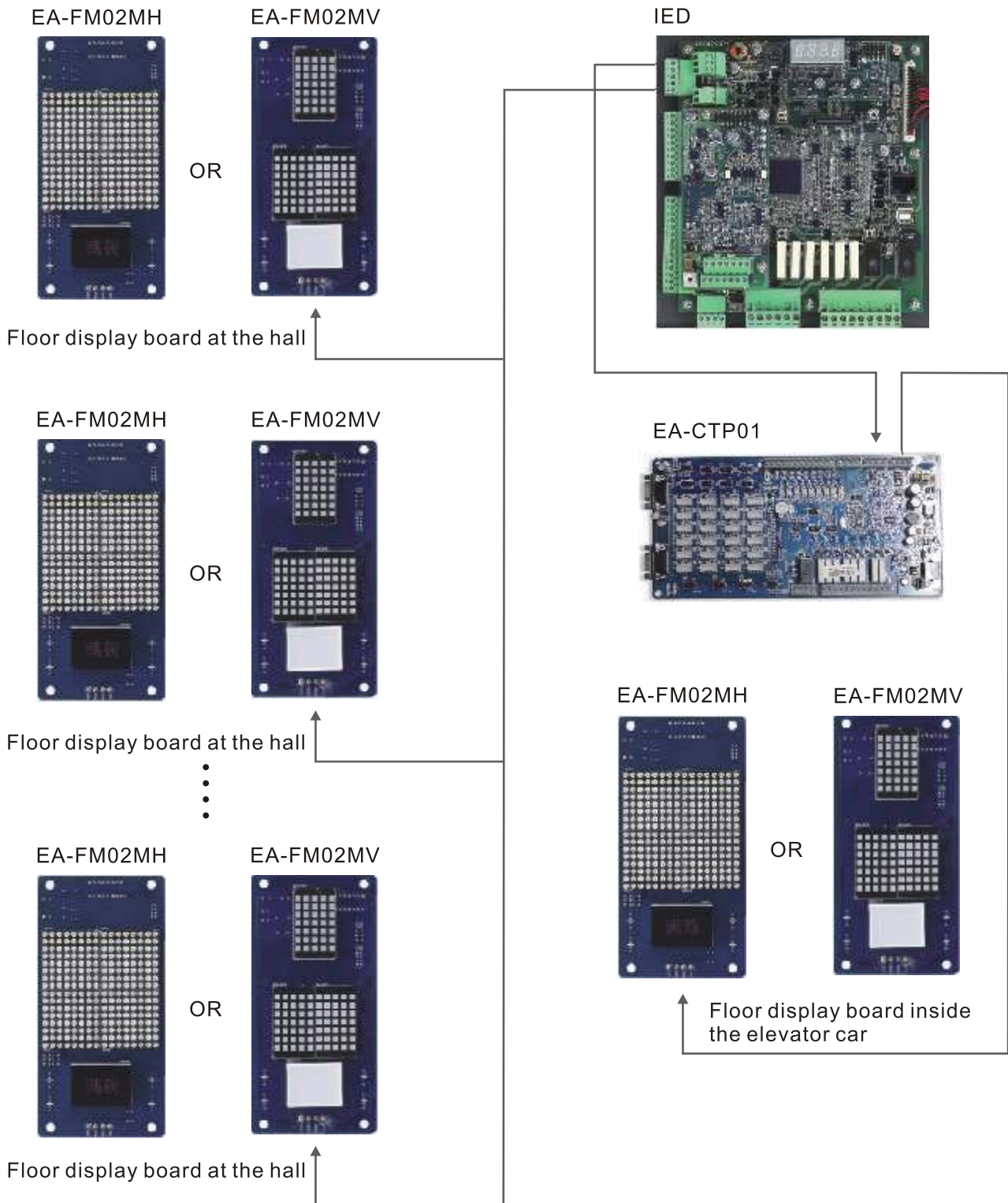

Asia



Taoyuan Technology Center



Taoyuan Plant 1



Taiwan's First Green Factory



Wujiang Plant 3



China Delta Greentech

Global Operations



▲ Factories 2 ■ Branch Offices



Tokyo Office



India Office



Eindhoven Office



Raleigh Office

Europe

America



64 R&D Centers 4 Distributors 584





Smarter. Greener. Together.

Industrial Automation Headquarters

Delta Electronics, Inc.

Taoyuan Technology Center
No.18, Xinglong Rd., Taoyuan City,
Taoyuan County 33068, Taiwan
TEL: 886-3-362-6301 / FAX: 886-3-371-6301

Asia

Delta Electronics (Jiangsu) Ltd.

Wujiang Plant 3
1688 Jiangxing East Road,
Wujiang Economic Development Zone
Wujiang City, Jiang Su Province,
People's Republic of China (Post code: 215200)
TEL: 86-512-6340-3008 / FAX: 86-769-6340-7290

Delta Greentech (China) Co., Ltd.

238 Min-Xia Road, Pudong District,
Shanghai, P.R.C.
Post code : 201209
TEL: 86-21-58635678 / FAX: 86-21-58630003

Delta Electronics (Japan), Inc.

Tokyo Office
2-1-14 Minato-ku Shibadaimon,
Tokyo 105-0012, Japan
TEL: 81-3-5733-1111 / FAX: 81-3-5733-1211

Delta Electronics (Korea), Inc.

1511, Byucksan Digital Valley 6-cha, Gasan-dong,
Geumcheon-gu, Seoul, Korea, 153-704
TEL: 82-2-515-5303 / FAX: 82-2-515-5302

Delta Electronics Int'l (S) Pte Ltd

4 Kaki Bukit Ave 1, #05-05, Singapore 417939
TEL: 65-6747-5155 / FAX: 65-6744-9228

Delta Electronics (India) Pvt. Ltd.

Plot No 43 Sector 35, HSIIDC
Gurgaon, PIN 122001, Haryana, India
TEL : 91-124-4874900 / FAX : 91-124-4874945

Americas

Delta Products Corporation (USA)

Raleigh Office
P.O. Box 12173, 5101 Davis Drive,
Research Triangle Park, NC 27709, U.S.A.
TEL: 1-919-767-3800 / FAX: 1-919-767-8080

Delta Greentech (Brasil) S.A

Sao Paulo Office
Rua Itapeva, 26 - 3º andar Edificio Itapeva One-Bela Vista
01332-000-São Paulo-SP-Brazil
TEL: +55 11 3568-3855 / FAX: +55 11 3568-3865

Europe

Deltronics (The Netherlands) B.V.

Eindhoven Office
De Witbogt 15, 5652 AG Eindhoven, The Netherlands
TEL: 31-40-2592850 / FAX: 31-40-2592851

*We reserve the right to change the information in this catalogue without prior notice.